







# NANO

system



**LEGENDA**

-  oscurante  
*blackout*
-  filtrante  
*semi shading*
-  pulire con panno umido  
*clean with a damp cloth*
-  ignifugo  
*fire retardant*
-  categoria prezzi  
*prices category*
-  REACH-compliant
-  Standard 100 by Oeko-Tex®

I dati tecnici di ogni tessuto sono visibili sotto i campioni tessili.  
*The technical data of each single fabric are visible under the samples.*

**NILUNA NEW**

**C**



-  
- 88204
- 88050
- 88733
- 88755
- 88199

**ASPEN**

**A**



- 10001
- 10025
- 10026
- 10055
- 10056



-    REACH 

- 10081
- 10007
- 10018
- 10019

**CREPE UNI NEW**

**A**



-  
- 81010
- 81726
- 81745
- 81040
- 81600

**MARBELLA**

**A**



-  
- 82010
- 82736
- 82600
- 82775
- 82580

**CADANS**

**B**



- 87004
- 87080
- 87099
- 87140

-   REACH 

- 87043
- 87002
- 87199

EXTRA ASPEN

C



11001

11025

11026

11055

NANO FOIL METAL

D



85087

DECOR PURE: TREVISO PRINT

B



24255

24253

24254

CETUS

A



83325

83070

83200

83913

83914

83260

CETUS SILVER

B

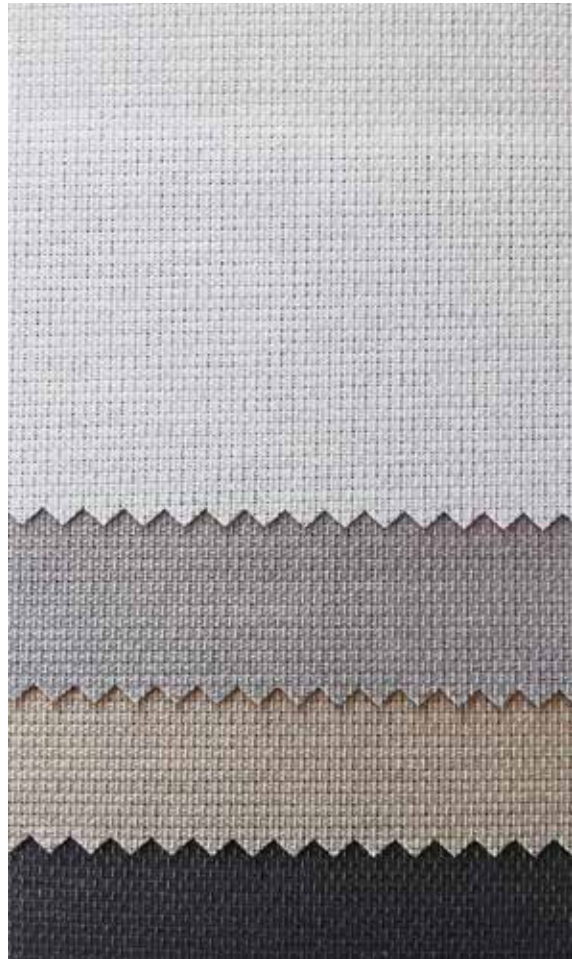

84325

84913

84371

84914

DECOR PURE: ECCENTRIC

B

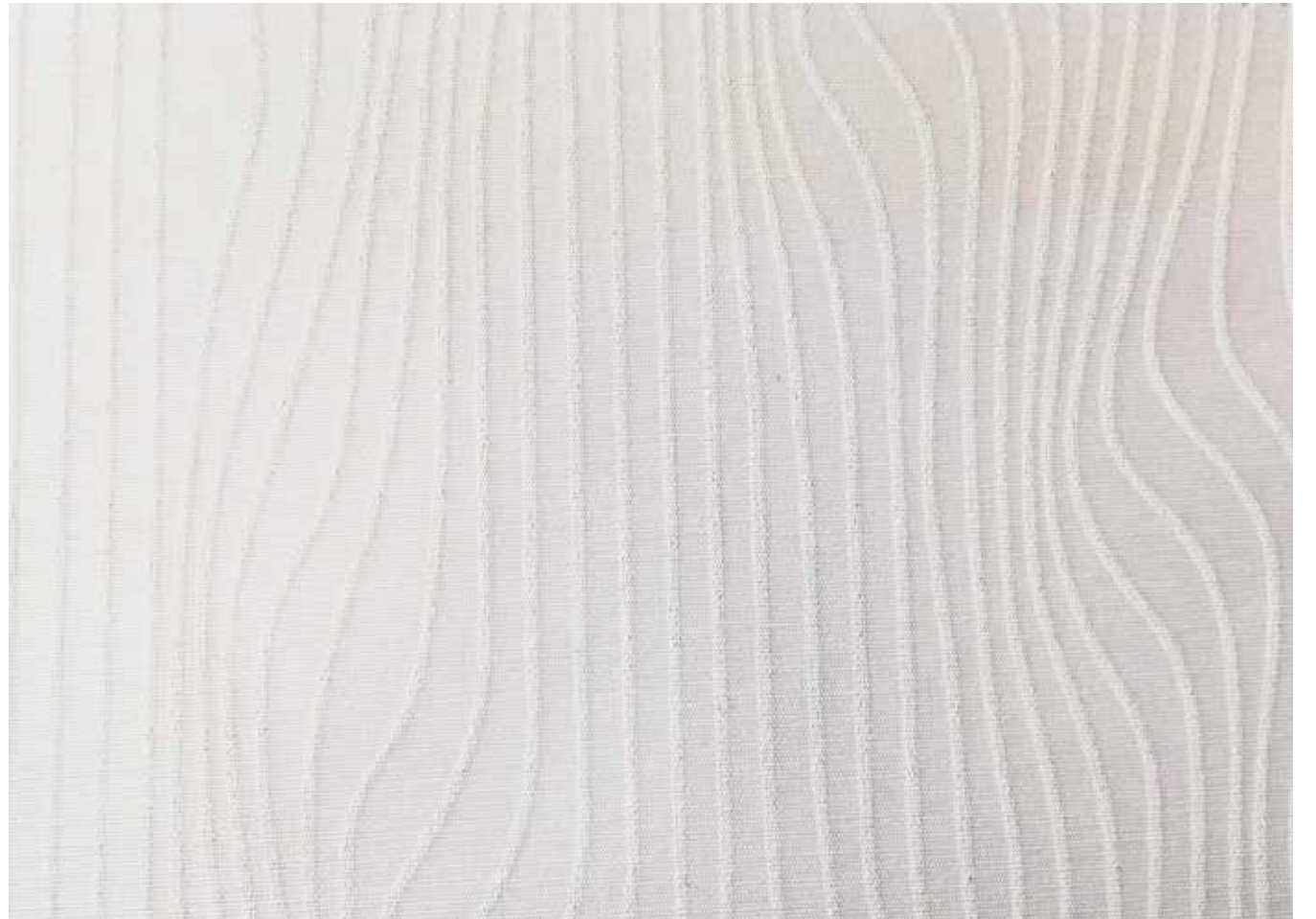

24864

**DATI TECNICI TECHNICAL DATA**

Cod.	Valori luminosi (%) Light values (%)			Valori solari (%) Solar values (%)			gtot INTERNAL blind			
	Riflessione Reflection	Trasmissione Transmission	Assorbimento Absorption	Riflessione Reflection	Trasmissione Transmission	Assorbimento Absorption	gv=0,59	class	gv=0,32	class
<b>C NILUNA NEW</b>										
88204	75,6	0,0	24,4	71	0	29	0,34	2	-	-
88050	75,6	0,0	24,4	71	0	29	0,34	2	-	-
88733	73,2	0,0	26,8	69	0	31	0,34	2	-	-
88755	75,7	0,0	24,3	70	0	29	0,35	1	-	-
88199	73,0	0,0	26,9	69	0	31	0,34	2	-	-
<b>A CREPE UNI NEW</b>										
81010	48,8	46,8	3,4	47,9	47,2	4,9	0,42	1	-	-
81726	49,0	43,8	7,2	47,3	44,3	8,4	0,42	1	-	-
81745	35,9	30,8	33,3	41,0	38,1	20,9	0,44	1	-	-
81040	32,2	31,0	36,7	39,5	40,4	20,1	0,45	1	-	-
81600	20,1	13,9	66,0	36,0	30,5	33,5	0,46	1	-	-
<b>A MARBELLA</b>										
82010	41,4	55,4	3,2	40,2	55,9	3,9	0,45	1	-	-
82736	39,0	52,9	8,1	38,6	54,0	7,3	0,45	1	-	-
82600	14,8	32,0	53,2	26,6	45,9	27,5	0,49	1	-	-
82775	9,4	21,9	68,7	24,8	38,0	37,2	0,50	0	-	-
82580	3,3	14,0	82,7	19,7	33,9	46,5	0,51	0	-	-
<b>A ASPEN</b>										
10001	68	0	32	49,1	0	50,9	0,40	1	-	-
10025	68	0	32	49,1	0	50,9	0,40	1	-	-
10026	68	0	32	49,1	0	50,9	0,40	1	-	-
10055	68	0	32	49,1	0	50,9	0,40	1	-	-
10056	68	0	32	49,1	0	50,9	0,40	1	-	-
10081	68	0	32	49,1	0	50,9	0,40	1	-	-
10007	68	0	32	49,1	0	50,9	0,40	1	-	-
10018	68	0	32	49,1	0	50,9	0,40	1	-	-
10019	68	0	32	49,1	0	50,9	0,40	1	-	-
<b>B CADANS</b>										
87004	38	47	-	42	42	-	0,55	0	-	-
87080	31	46	-	32	43	-	0,55	0	-	-
87099	23	27	-	24	26	-	0,55	0	-	-
87140	15	15	-	14	13	-	0,55	0	-	-
87043	14	16	-	14	14	-	0,55	0	-	-
87002	14	11	-	15	11	-	0,55	0	-	-
87199	14	10	-	15	9	-	0,55	0	-	-
<b>C EXTRA ASPEN</b>										
11001	57	0	43	55	0	45	0,39	1	0,26	2
11025	57	0	43	55	0	45	0,39	1	0,26	2
11026	57	0	43	55	0	45	0,39	1	0,26	2
11055	57	0	43	55	0	45	0,39	1	0,26	2
<b>D NANO FOIL METAL</b>										
85087	3	72	-	4	72	-	0,34	2	-	-
<b>A CETUS</b>										
83325	51	46	3	49	47	4	0,47	1	-	-
83070	52	44	4	47	45	8	0,46	1	-	-
83200	47	39	14	45	40	15	0,46	1	-	-
83913	31	27	42	40	38	22	0,50	0	-	-
83914	28	20	52	45	33	22	0,49	1	-	-
83260	15	15	70	13	18	69	0,51	0	-	-
<b>B CETUS SILVER</b>										
84325	56	10	34	57	10	33	0,41	1	-	-
84913	52	8	40	54	10	36	0,42	1	-	-
84371	54	9	37	56	10	34	0,41	1	-	-
84914	46	7	47	52	11	37	0,43	1	-	-
<b>B DECOR PURE: TREVISO PRINT</b>										
24255	39	61	0	38	62	0	0,46	1	0,28	2
24253	13	27	60	22	46	32	0,51	0	0,29	2
24254	38	55	7	37	58	5	0,46	1	0,28	2
<b>B DECOR PURE: ECCENTRIC</b>										
24864	44	45	11	45	46	9	0,43	1	0,27	2

Tessuto + vetro - Fabric + glazing

**COMFORT CLASSIFICATION**  
According to EN 14501 standard

**0** effetto molto scarso  
very little effect

**1** effetto scarso  
little effect

**2** effetto moderato  
moderate effect

**3** effetto buono  
good effect

**4** effetto ottimale  
very good effect

**gv = 0,59:** fattore solare con vetro standard (C) basso emissivo 4/16/4, vetrocamera riempita con Argon (U valore termico di trasmittanza = 1,2 W/m²K)

**gv = 0,32:** fattore solare con vetro standard (D) riflettente basso emissivo 4/16/4, vetrocamera riempita con Argon (U valore termico di trasmittanza = 1,1 W/m²K)

Campioni testati sulla base dello standard EN 14500 che definisce le misurazioni e i metodi di calcolo come specificato nello standard EN 13363-2 "Dispositivi di protezione solare in combinazione con vetrate - Calcolo della trasmittanza solare e luminosa - Parte 2: Metodo dettagliato" e EN 410 "Vetro per edilizia - Determinazione delle caratteristiche luminose e solari delle vetrate."

**gv = 0,59:** solar factor of standard glazing (C), low-emission 4/16/4 double glazing filled with Argon (U value thermal transmittance = 1,2 W/m²K)

**gv = 0,32:** solar factor of standard glazing (D), reflecting low-emission 4/16/4 double glazing filled with Argon (U value thermal transmittance = 1,1 W/m²K)

Samples tested according to EN 14500 standard defining the measurements and calculation methods as specified in the standard EN 13363-2 "Solar protection devices combined with glazing calculation of solar and light transmittance - part 2: EN 13363-2 detailed method" and EN 410 "Glass in building - Determination of luminous and solar characteristics of glazing".



Fra ordini diversi non può essere garantita una costante omogeneità di colore nei tessuti, essendo inevitabile riscontrare variazioni di tonalità tra i diversi lotti di produzione. I dati presenti in questo documento sono da considerarsi a scopo informativo e non possono essere considerati come vincolanti.

The colour of the fabric may vary from order to order, as the variation of tone is intrinsic to both production processes. The data in this document is for information only and may not be considered as binding.

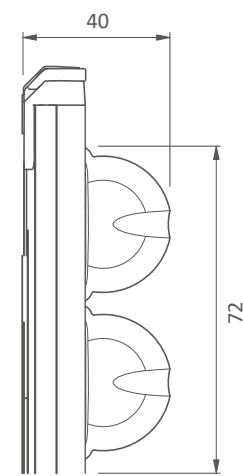
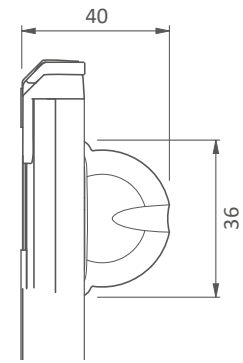
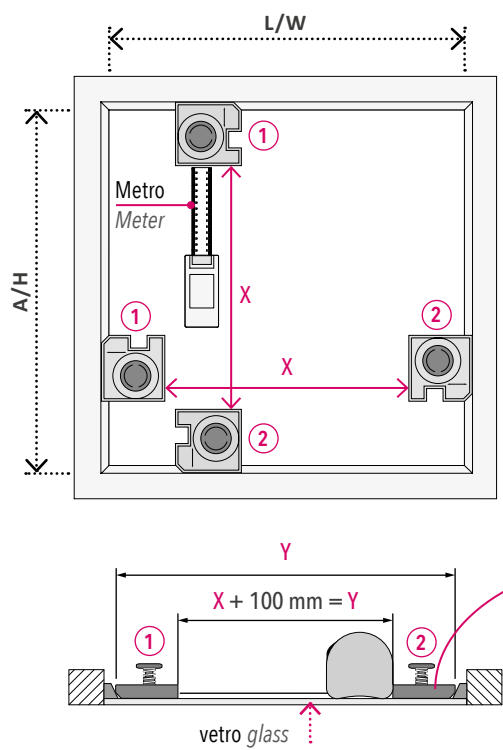

**RILIEVO MISURE HOW TO MEASURE**

Posizionare due distanziatori (1 e 2) ai lati opposti della finestra e misurare con un metro la misura X. Ripetere l'operazione in tre diversi punti, sia per l'altezza (A) che per la larghezza (L). Prendere in considerazione l'altezza e la larghezza più piccole misurate (X) e aggiungere ad entrambe 100 mm (Y).

**ATTENZIONE:** per tende di grandi dimensioni, con tessuti oscuranti, è inevitabile la presenza di ondulazioni laterali.

Place two measuring tools (1 and 2) at opposite sides of the window and measuring by a meter the size X. Repeat the operation in three different points, for both the height (H) and width (W). Use the smallest height and width measured (X) and add 100 mm to both (Y).

**ATTENTION:** big blinds with black-out fabrics may have wavy edges.

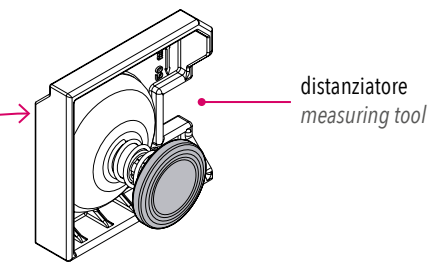

**LIMITI DIMENSIONALI DIMENSIONAL LIMITS**

NANO SINGOLA - SINGLE NANO			
Larghezza Width		Altezza Height	
Min.	Max.	Min.	Max.
35 cm	125 cm	40 cm	140 cm

La struttura è disponibile nelle seguenti tinte verniciate: Bianco, Avorio RAL 1013, Grigio, Marrone RAL 8017, Nero RAL 9005 opaco. Altre tinte RAL a richiesta.

Con l'utilizzo del tessuto CADANS (CAT. B) l'altezza max. consentita è 110 cm. Con l'utilizzo del tessuto CETUS (CAT. A) l'altezza max. consentita è 130 cm. Con l'utilizzo del tessuto CETUS SILVER (CAT. B) l'altezza max. consentita è 120 cm.

Standard colours powder coated: White, Ivory RAL 1013, Grey, Brown RAL 8017, Black RAL 9005 matt finish. Other RAL on request.

For installation with fabric CADANS (CAT. B) the maximum height is 110 cm. For installation with fabric CETUS (CAT. A) the maximum height is 130 cm. For installation with fabric CETUS SILVER (CAT. B) the maximum height is 120 cm.

NANO DOPPIA - DOUBLE NANO			
Larghezza Width		Altezza Height	
Min.	Max.	Min.	Max.
35 cm	125 cm	60 cm	230 cm

La struttura è disponibile nelle seguenti tinte verniciate: Bianco, Avorio RAL 1013, Grigio, Marrone RAL 8017, Nero RAL 9005 opaco. Altre tinte RAL a richiesta.

Con l'utilizzo del tessuto CADANS (CAT. B) l'altezza max. consentita è 220 cm. Con l'utilizzo del tessuto NANO FOIL METAL (CAT. D) per applicazioni su finestre VERTICALI e VASISTAS, l'altezza max. consentita è 150 cm. Per applicazioni su finestre VASISTAS l'altezza max. consentita per tutti gli altri tessuti è 180 cm.

Standard colours powder coated: White, Ivory RAL 1013, Grey, Brown RAL 8017, Black RAL 9005 matt finish. Other RAL on request.

For installation with fabric CADANS (CAT. B) the maximum height is 220 cm. For installation on VERTICAL windows or VASISTAS windows with fabric NANO FOIL METAL (CAT. D) the maximum height is 150 cm. For installation on VASISTAS windows with other fabrics the maximum height is 180 cm.



RILIEVO MISURE  
HOW TO MEASURE



NANO SINGOLA  
SINGLE NANO



NANO DOPPIA  
DOUBLE NANO



**RESSTENDE®**

Nuovi stili di vita, nuovi sistemi di tende

**Resstende S.r.l.**

[info@resstende.com](mailto:info@resstende.com)

[resstende.com](http://resstende.com)

