

Z 725

C104 GS40 ARGANO - CRANK

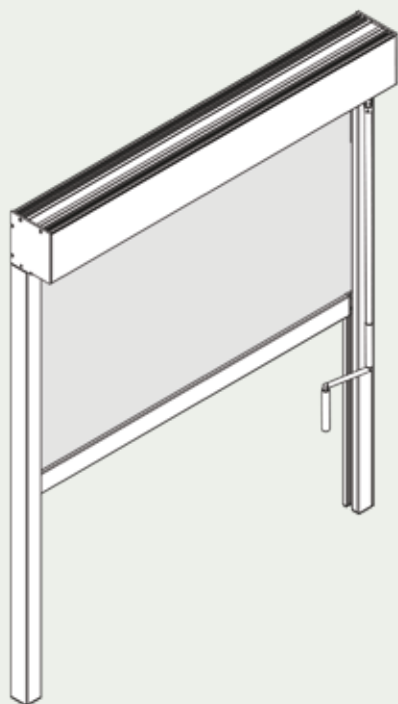

dimensioni espresse in mm  
dimensions shown in mm

C104

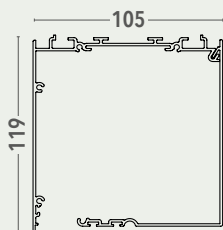

RULLO TUBE

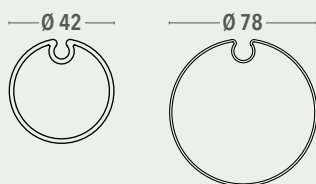

GS40

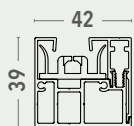

FZ47

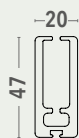

F56

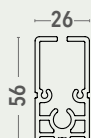

### VARIANTI - OPTIONAL

- profilo antipioggia in PVC (bianco, grigio, nero) per fondale FZ47/F56 (maggiorato)

PVC waterproof strip (white, grey, black) for FZ47 hem bar. Oversize model for F56 hem bar

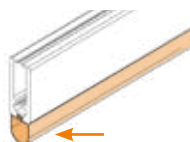

### CARATTERISTICHE - CHARACTERISTICS

- Tipo di applicazione:** verticale - *Application:* vertical
- Ambiente di applicazione:** interno/esterno - *Installation:* indoor/outdoor
- Cassonetto:** squadrato C104 in alluminio estruso composto da una parte fissa e una mobile ispezionabile; coppie di testate autoportanti o per attacco laterale in alluminio verniciato in tinta con il cassonetto  
*Headbox:* squared C104 extruded aluminum headbox with removable cover and powder coated aluminum end cheeks that permit the box to be fitted directly to the side channels or end cheeks for side mounting
- Rullo di avvolgimento:** Ø 42 mm in alluminio estruso oppure Ø 78 mm in acciaio zincato con ogiva per agevolare la manutenzione del telo  
*Roller tube:* Ø 42 mm extruded aluminum tube or Ø 78 mm galvanized steel tube with slot to facilitate fabric removal
- Guide:** GS40 con profilo di chiusura in alluminio estruso e anima interna con alette in PVC per un perfetto scorrimento e trattenimento del telo in guida. Profilo di chiusura per guida a incasso a supplemento. Le guide del sistema ZIP garantiscono oscuramento ove richiesto  
*Side channels:* GS40 extruded aluminum side channels in two parts with winged inner rail in PVC. Side channel cover for encasement on request. The ZIP system ensures smooth operation keeping the fabric inside the channels and provides blackout where required
- Fondale:** FZ47 piatto in alluminio estruso adeguatamente zavorrato con profilo in ferro zincato, completo di tappi scorrevoli in PVC e spazzolino. A richiesta profilo in gomma antipioggia (bianco, grigio, nero). A supplemento sistema Ultra Lock con fondale F56 piatto in alluminio estruso con tappi scorrevoli in PVC e profilo antipioggia maggiorato (solo con arganello grande rapporto giri 1:4,7)  
*Hem bar:* FZ47 extruded aluminum weighted flat hem bar with PVC end caps and brush. PVC waterproof strip (white, grey, black) on request. On supplement Ultra Lock system (compatible with big gear box ratio 1:4.7) with F56 extruded aluminum weighted flat hem bar with PVC end caps and oversize PVC waterproof strip
- Manovra:** ad arganello in zama, rapporto giri 1:3,3 con fine corsa (rullo Ø 42 mm) o rapporto giri 1:4,7 senza fine corsa (rullo Ø 78 mm). Asta tubolare Ø 13 mm in alluminio estruso, asportabile, con attacco magnetico; maniglia snodabile con impugnatura in PVC, ferma asta in PVC. A supplemento rinvio di manovra 90°  
*Operation:* crank operation, gear box ratio 1:3.3 in zama with endstop (Ø 42 mm) or gear box ratio 1:4.7 in zama without endstop (Ø 78 mm). Ø 13 mm removable aluminum crank rod with magnetic coupling, PVC coated jointed handle and PVC clip. 90° through wall coupling on supplement
- Fissaggio guide:** frontale o laterale - *Side channels mounting:* wall or mounting in recess
- Fissaggio cassonetto:** autoportante in guida o con testate per attacco laterale  
*Headbox mounting:* box self supporting on side channels or side mounting of the headbox

### COLORI STANDARD - STANDARD COLOURS

#### cassonetto headbox

	bianco Ral 9010 - white Ral 9010		grigio Ral 7016 opaco - matt grey Ral 7016
	bianco Ral 9016 opaco - matt white Ral 9016		grigio micaceo liscio - smooth micaceous grey
	avorio Ral 1013 - ivory Ral 1013		nero Ral 9005 opaco - matt black Ral 9005
	marrone Ral 8017 - brown Ral 8017		argento anodizzato - silver anodised

#### asta di manovra argano asportabile removable crank rod

	bianco Ral 9010 - white Ral 9010		nero Ral 9005 opaco - matt black Ral 9005
	argento anodizzato - silver anodised		

### TESSUTI ABBINABILI - SUITABLE FABRICS

- Consultare la **TABELLA A - UTILIZZO TESSUTO** nella sezione tessuti  
*Consult TAB A - FABRICS in fabric section*

### SUPPLEMENTI - SUPPLEMENT



### NOTE - NOTES

- La guida GS40 non consente l'utilizzo di teli finestrati  
*GS40 side channel is not suitable for fabrics with transparent windows*

### VARIANTE CON SISTEMA DI BLOCCAGGIO ULTRA LOCK OPTIONAL WITH ULTRA BLOCK SYSTEM



- La **tecnologia ULTRA LOCK** garantisce la chiusura della tenda e simultaneamente il bloccaggio e il tensionamento del telo per una maggior sicurezza e resistenza al vento.

È un supplemento applicabile solo con fondale F56 e profilo antipioggia maggiorato. (Solo con arganello grande rapporto giri 1:4,7) **MAX L 300X300 H**

*The technology of ULTRA LOCK enables the blind to be closed, locked and tensioned for a major security and a better resistance to the wind. It is a supplement suitable for F56 hem bar and oversize PVC waterproof strip only. (Compatible with big gear box ratio 1:4.7) MAX W 300X300 H*



### GUIDA GS40 GS40 SIDE CHANNEL

- Particolare di GS40 con profilo di chiusura e anima interna con alette in PVC per un perfetto scorrimento e trattenimento in guida del telo e, ove richiesto, un effetto oscuramento

*GS40 side channels with cover and winged inner rail in PVC: the ZIP system ensures smooth operation keeping the fabric inside the channels and provides blackout where required*

